

Data Sheet



Article number: 5863502810

Description: Ball Valve 350.2810, G 1/2" - G 1/2"
Thread/Thread

Measures

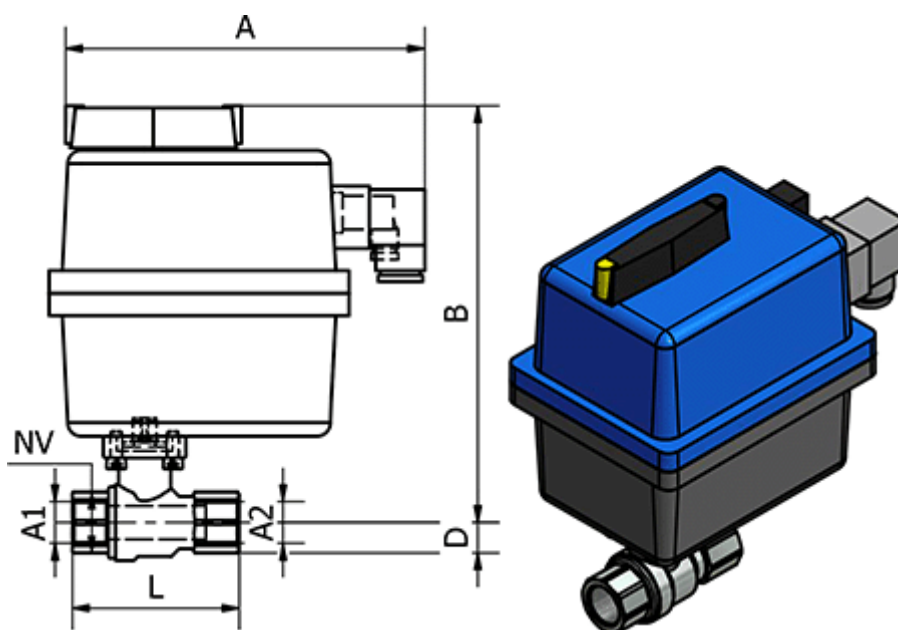

= -	D	= 14
= -	L	= 75
= -	Max. Operating Pressure	= 40 bar
= -	NV	= 26

A = 177

B = 214

Connecting A1 = G 1/2"

Connecting A2 = G 1/2"